

Part Number : **CMQ5675400**

Type	Size	Rating	Description
Sealed-beam	PAR56	75V 400W	Locomotive Halogen Lamp

Dimensions (mm):

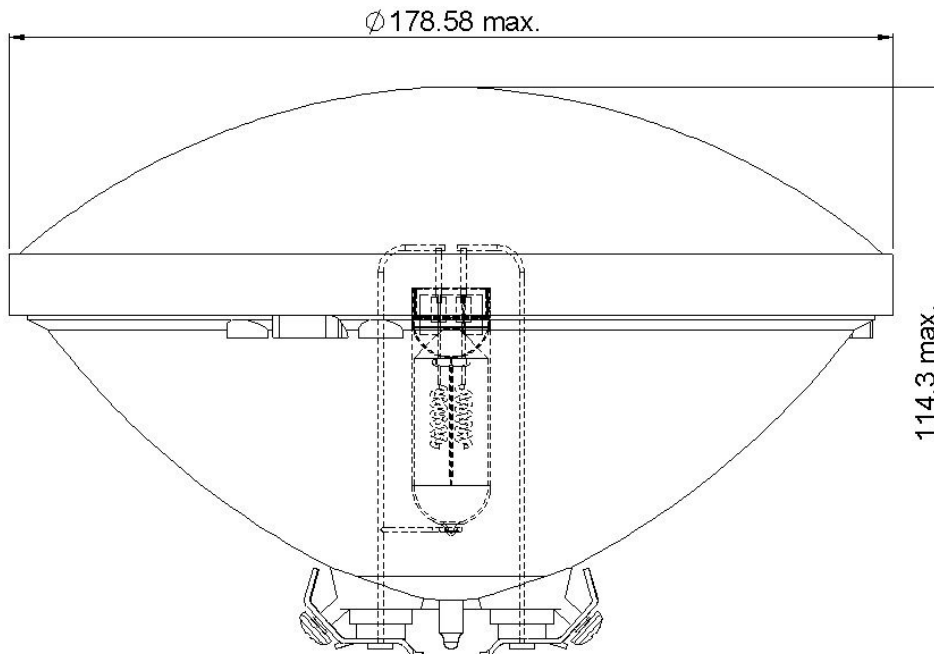

Design Voltage (V)	Design Power (W)	Luminous Intensity (cd)			Average Life (Hr)
		Peak	± 7.5°	± 20°	
75	400	200,000 min.	3,000 min.	400 min.	3,200

Notes:

1. Marking Information: Part No., Voltage, Wattage, Date (dd/mm/yyyy) and Traceability Code
2. Filament Designation: 2 x CC-8
3. Base: Screw Terminal
4. Application: Designed to meet the requirements of 49 CFR §229.125